

XH260L – XH260V

TEMPERATURE AND HUMIDITY CONTROLLER

1. GENERAL WARNING

1.1 PLEASE READ BEFORE USING THIS MANUAL

- This manual is part of the product and should be kept near the instrument for easy and quick reference.
- The instrument shall not be used for purposes different from those described hereunder. It cannot be used as a safety device.
- Check the application limits before proceeding.

1.2 SAFETY PRECAUTIONS

- Check the supply voltage is correct before connecting the instrument.
- Do not expose to water or moisture: use the controller only within the operating limits avoiding sudden temperature changes with high atmospheric humidity to prevent formation of condensation
- Warning: disconnect all electrical connections before any kind of maintenance.
- Fit the probe where it is not accessible by the End User. The instrument must not be opened.
- In case of failure or faulty operation send the instrument back to the distributor or to "Dixell s.r.l." (see address) with a detailed description of the fault.
- Consider the maximum current which can be applied to each relay (see Technical Data).
- Ensure that the wires for probes, loads and the power supply are separated and far enough from each other, without crossing or intertwining.
- In case of applications in industrial environments, the use of mains filters (our mod. FT1) in parallel with inductive loads could be useful.

2. GENERAL DESCRIPTION

The XH260L, 38x185 format, and the XH260V, 100x64 format, are microprocessor controllers, suitable for applications on medium or low temperature refrigerating units. They control both humidity and temperature. They have 6 output relays to control compressor, heating elements, defrost, fan dehumidifier and humidifier. They have 2 NTC inputs one for thermostat the other one for defrost. It's also present and 4÷20mA input for humidity. There is one digital input (free contact) configurable by parameter. An output allows the user to programme the parameter list with the "Hot Key".

3. TEMPERATURE REGULATION

The temperature regulation is performed through neutral zone using compressor and heater output relays.

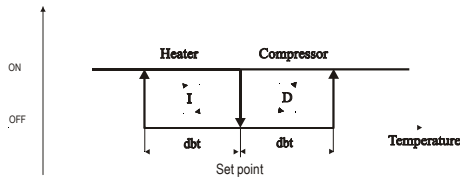

- **Heating output:** CUT IN is "SET_TEMP-dbt", CUT OUT is when the temperature reaches the set point.
- **Compressor output:** CUT IN is "SET_TEMP +dbt", CUT OUT is when the temperature reaches the set point.

3.1 DEFROST

Two defrost modes are available through the "tdF" parameter: defrost with electrical heater or hot gas. The defrost interval is control by means of parameter "EdF": (EdF=in) the defrost is made every "IdF" time, (EdF=Sd) the interval "IdF" is calculate through Smart Defrost algorithm (only when the compressor is ON).

To **disable** the defrost set the **MdF** parameter to **zero**

Humidity regulation during a defrost depends on the **Hud** parameter. With **Hud=no** humidity regulation is disabled. Con **Hud=yES** humidity regulation is performed also during a defrost.

4. HUMIDITY REGULATION

The humidity regulation is performed through neutral zone, by humidifying dehumidifying actions. Humidity control can be disabled setting the **SET_RH** to "nu" value. In this case only the temperature control is perform.

4.1 HUMIDIFYING ACTION

The humidifying action is done enabling the humidifier relay when the humidity is lower than the "SET_RH-dbh" value. The relay is switch off when humidity reaches the set values.

4.2 DEHUMIDIFYING ACTION WITHOUT DEHUMIDIFIER RELAY (OA1 DIFFERENT FROM DEH) – STANDARD CONFIGURATION

In this case the dehumidifying action is performed by setting the following parameters in this way:
tHu = c-H kind of dehumidifying by means of heating and compressor relays
oA1 different from dEH:

The heating and compressor outputs are activated together when humidity is higher than SET_RH+dbh value. Outputs are disabled when humidity comes back to the SET_RH value.

4.2.1 Relation between cooling, heating and dehumidifying

1. If is simultaneously present a request of cooling (temp>SET_TEMP+dbt) and dehumidifying (RH > SET_RH+dbh): the cooling action has the priority over the dehumidifying action: only the compressor relay is energised till the SET_TEMP is reached at this point also the heating relay is enabled.

2. If is simultaneously present a request of heating (temp<SET_TEMP-dbt) and dehumidifying (RH > SET_RH+dbh): the dehumidifying action has the priority over the heating action: both the compressor and the heating relays are energised till the humidity set is reached at this point only the heating relay is enabled.

4.3 DEHUMIDIFYING ACTION WITH DEHUMIDIFIER RELAY (OA1 = DEH)

The configurable relay is used, (XH260L terminals 3-4, XH260V terminals 11-12) setting the parameter **oA1=dEH**.

NOTE: the LIGHT button is not more available;
 Two kinds of de-humidifying are available:

4.3.1 Dehumidifying action with ONLY de-humidifier relay

By setting the parameter **tHu = db** the de-humidifying action is performed by enabling the de-humidifier relay when the humidity is higher than SET_RH + dbH.
 The relay is switch off when humidity comes back to the SET_RH value.

4.3.2 Dehumidifying action with de-humidifier and compressor relays

By setting the parameter **tHu = cHu** the de-humidifying action is performed by enabling the de-humidifier and compressor relays together. when the humidity is higher than SET_RH + dbH.
 The relays are switched off when humidity comes back to the SET_RH value.

If is simultaneously present a request of cooling (temp>SET_TEMP+dbt) and dehumidifying (RH > SET_RH+dbh): the cooling action has the priority over the dehumidifying action: only the compressor relay is energised till the SET_TEMP is reached at this point also the de-humidifier is enabled.

5. FANS

The fan control mode is selected by means of the "FnC" parameter:

- FnC=C-n** fans will switch ON and OFF with the compressor and **not run** during defrost;
- FnC=O-n** fans will run continuously, but not during defrost
- FnC=C-y** fans will switch ON and OFF with the compressor and **run** during defrost;
- FnC=O-y** fans will run continuously also during defrost

6. THE DISPLAY



- To display and modify target temperature set point. (SET_TEMP)
- To display and modify target humidity set point (SET_RH); in programming mode it selects a parameter or confirm an operation.
- In programming mode it browses the parameter codes or increases the displayed value.
- To start a manual defrost: hold it pressed for at least 3s. In programming mode it browses the parameter codes or decreases the displayed value.
- Switch ON and OFF the light, if present (oA1=lig)
- Switch ON and OFF the instrument.

KEY COMBINATIONS

- To lock and unlock the keyboard
- To enter the programming mode.
- To exit the programming mode.

6.1 ICONS AND SYMBOLS

Each LED function is described in the following table.

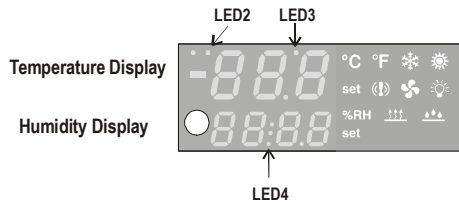

LED	MODE	FUNCTION
Led 4	ON	- Instrument in stand by. - In "Pr2" indicates that the parameter is also present in "Pr1".
°C	ON	°C
°F	ON	°C
❄️	ON	The compressor is running
❄️	FLASHING	- Anti-short cycle delay enabled
❄️	ON	The defrost is enabled
LED 3	FLASHING	Drip time in progress
LED 3	FLASHING	Drip time in progress
LED 2	FLASHING	Programming Phase (flashing with LED3)
☀️	ON	Heating enabled
set (temp)	FLASHING	Temperature Set programming phase
🔔	ON	- ALARM signal
🌀	ON	Fan is running
💡	ON	The light is on
%RH	ON	RH%
↑↑↑	ON	Dehumidifying enabled
↓↓↓	ON	Humidifying enabled
set (umid)	FLASHING	Humidity Set programming phase

6.2 HOW TO SEE AND MODIFY THE SET POINT (TEMPERATURE AND HUMIDITY)

1. Push and immediately release the SET key: the display will show the Set point value and the correspondent set icon starts flashing;
2. To change the Set value push the ▲ or ▼ arrows within 10s.
3. To memorise the new set point value push the SET key again or wait 10s.

6.3 TO START A MANUAL DEFROST

1. Push the DOWN key for more than 2 seconds and a manual defrost will start.

6.4 TO ENTER IN PARAMETERS LIST "PR1"

To enter the parameter list "Pr1" (user accessible parameters) operate as follows:

1. Enter the Programming mode by pressing the SET_RH+ ▼ for few seconds. (LED2&3 start flashing)
2. The instrument will show the first parameter present in "Pr1"

6.5 TO ENTER IN PARAMETERS LIST "PR2"

To access parameters in "Pr2":

1. Enter the "Pr1" level.
2. Select "Pr2" parameter and press the "SET_RH" key.
3. The "PAS" flashing message is displayed, shortly followed by "0 -" with a flashing zero.
4. Use ▲ or ▼ to input the security code in the flashing digit; confirm the figure by pressing "SET_RH".

The security code is "321".

5. If the security code is correct the access to "Pr2" is enabled by pressing "SET_RH" on the last digit.

Another possibility is the following: after switching ON the instrument the user can push SET_RH + ▼ keys within 30 seconds.

NOTE: each parameter in "Pr2" can be removed or put into "Pr1" (user level) by pressing SET_RH + ▼. When a parameter is present in "Pr1" LED 4 is on.

6.6 TO CHANGE PARAMETER VALUES

1. Enter the Programming mode.
2. Select the required parameter with ▲ or ▼.
3. Press the "SET_RH" key to display its value (LED2&3 start blinking).
4. Use ▲ or ▼ to change its value.
5. Press "SET_RH" to store the new value and move to the following parameter.

To exit: Press SET_RH + UP or wait 15s without pressing a key.

NOTE: the new programming is stored even when the procedure is exited by waiting the time-out.

6.7 HOW TO LOCK THE KEYBOARD

1. Keep the ▲ and ▼ keys pressed together for more than 3 s the ▲ and ▼ keys.



2. The "POF" message will be displayed and the keyboard is locked. At this point it is only possible the viewing of the set point or the MAX o Min temperature stored and to switch ON and OFF the light, the auxiliary output and the instrument.

TO UNLOCK THE KEYBOARD

Keep the ▲ and ▼ keys pressed together for more than 3s.

6.8 ON/OFF FUNCTION



By pushing the ON/OFF key, the instrument shows "OFF" for 5 sec. and the ON/OFF LED is switched ON.

During the OFF status, all the relays are switched OFF and the regulations are stopped; N.B. During the OFF status the LED4 button is lighted.

7. PARAMETER LIST

REGULATION

- dbt** half dead band width for temperature: (0,1+25,5°C; 1+45°F) this band is place below and above the temperature set point (SET_TEMP). The compressor is enabled when the temperature increases and reaches the SET_TEMP + dbt value. It is turned off when it comes back to the SET_TEMP. The heating output is enabled when temperature is less than SET_TEMP -dbt value and disabled when the SET_TEMP is reached.
- dbH** half dead band width for humidity: (0,5+25,5RH) this band is place below and above the humidity set point (SET_RH). The dehumidifying action is enabled when the humidity increases and reaches the SET_RH + dbH value. It is stopped when it comes back to the SET_RH. The humidifying output is enabled when humidity is less than SET_RH -dbH value and disabled when the SET_RH is reached.
- LS** Minimum temperature set point limit: (-50,0°C+SET; -58°F+SET) Sets the minimum acceptable value for the set point.
- US** Maximum temperature set point limit: (SET+110°C; SET+230°F) Set the maximum acceptable value for set point.
- Ods** Outputs activation delay at start up: (0+255 min) This function is enabled at the initial start up of the instrument and inhibits any output activation for the period of time set in the parameter. (Light can work)
- AC** Anti-short cycle delay: (0+30 min) interval between the compressor stop and the following restart.
- tHu** Kind of de-humidifying: db: only with de-humidifier relay (oA1= dEH)
cHu with de-humidifier and compressor relay (oA1= dEH)
c-H: without de-humidifier relay, by means of compressor and heating relays (oA1≠ dEH).
- LSH** Minimum humidity set point limit: (Lci + Set H) Sets the minimum acceptable value for the humidity set point.
- USH** Maximum humidity set point limit: (Set H + uci) Set the maximum acceptable value for humidity set point.

DISPLAY

- CF** Measurement unit: °C= Celsius; °F= Fahrenheit
- rES** Resolution (for °C): allows decimal point display. dE = 0,1°C; in = 1 °C
- rEH** Resolution for RH%: in = integer; Hd= half digit.

DEFROST

- tdF** Defrost type: rE = electrical heater (Compressor OFF)
in = hot gas (Compressor and defrost relays ON)
- EdF** Defrost mode: in = interval mode. The defrost starts when the time "ldf" is expired.
Sd = Smartfrost mode. The time ldf (interval between defrosts) is increased only when the compressor is running (even non consecutively).
- SdF** Set point for SMARTFROST: (-30+30 °C/ -22-86 °F) evaporator temperature which allows the ldf counting (interval between defrosts) in SMARTFROST mode.
- dtE** Defrost termination temperature: (-50,0+110,0°C; -58+230°F) (Enabled only when the evaporator probe is present) sets the temperature measured by the evaporator probe which causes the end of defrost.
- ldF** Interval between defrosts: (1+120h) Determines the time interval between the beginning of two defrost cycles.
- mdF** Duration of defrost: (0+255 min) When P2P = n, no evaporator probe, it sets the defrost duration, when P2P = y, defrost end based on temperature, it sets the maximum length for defrost.
- dFd** Display during defrost: rt = real temperature; it = temperature reading at the defrost start;
Set = set point; dEF = "dEF" label; dEG = "dEG" label;
- dAd** Defrost display time out: (0+255 min) Sets the maximum time between the end of defrost and the restarting of the real room temperature display.
- Fdt** Drain down time: (0+60 min.) time interval between reaching defrost termination temperature and the restoring of the control's normal operation. This time allows the evaporator to eliminate water drops that might have formed due to defrost.
- dPO** First defrost after start-up: y = Immediately; n = after the ldf time
- Hud** Humidity control during defrost: no: the humidity control is stopped during the defrost; yES the humidity control works also during the defrost.

FANS

- FnC** Fan operating mode: C-n = running when a load is on, OFF during the defrost;
C-y = running when a load is on, ON during the defrost;
O-n = continuous mode, OFF during the defrost; O-y = continuous mode, ON during the defrost;

TEMPERATURE ALARMS

- ALC** Temperature alarm configuration: rE = High and Low alarms related to Set Point
Ab = High and low alarms related to the absolute temperature.
- ALL** Low temperature alarm setting: ALC = rE, 0 + 50 °C or 90°F
ALC = Ab, - 50°C or -58°F + ALU
when this temperature is reached and after the ALD delay time, the LA alarm is enabled,.
- ALU** High temperature alarm setting: ALC= rE, 0 + 50°C or 90°F
ALC= Ab, ALL + 110°C or 230°F
when this temperature is reached and after the ALd delay time the HA alarm is enabled.
- ALH** Temperature alarm recovery differential: (0,1+25,5°C; 1+45°F) Intervention differential for recovery of temperature alarm.
- ALd** Temperature alarm delay: (0+255 min) time interval between the detection of an alarm condition and the corresponding alarm signalling.

- dAO Delay of temperature alarm at start-up:** (0min+23h 50min) time interval between the detection of the temperature alarm condition after the instrument power on and the alarm signalling.
- EdA Alarm delay at the end of defrost:** (0+255 min) Time interval between the detection of the temperature alarm condition at the end of defrost and the alarm signalling.
- dot Delay of temperature alarm after closing the door :** (0+255 min) Time delay to signal the temperature alarm condition after closing the door.

HUMIDITY ALARMS

- AHC Humidity alarm configuration:** rE = High and Low alarms related to humidity Set Point
Ab = High and low alarms related to the "absolute" humidity.
- AHL Low humidity alarm setting:** (with AHC = rE: 0 ÷ 50. With AHC = Ab: Lci ÷ AHu) when this humidity is reached and after the AHd delay time, the HLA alarm is enabled,.
- AHu High humidity alarm setting:** (with AHC = rE: 0+50°C. with AHC = Ab: AHL ÷ uci) when this humidity is reached and after the AHd delay time the HHA alarm is enabled.
- AHH Humidity alarm recovery differential:** (0.5+20.0) Intervention differential for recovery of humidity alarm.
- AHd Humidity alarm delay:** (0+255 min) time interval between the detection of an alarm condition and the corresponding alarm signalling.
- dHo Delay of humidity alarm at start-up:** (0min+23h 50min) time interval between the detection of the humidity alarm condition after the instrument power on and the alarm signalling.
- doH Alarm delay at the end of defrost:** (0+255 min) Time interval between the detection of the humidity alarm condition at the end of defrost and the alarm signalling.
- doA Open door alarm delay:**(0+255 min) delay between the detection of the open door condition and its alarm signalling: the flashing message "dA" is displayed.
- nPS Pressure switch number:** (0 ÷15) Number of activation of the pressure switch, during the "did" interval, before signalling the alarm event (I2F= PAL).
If the nPS activation in the "did" time is reached, switch off and on the instrument to restart normal regulation.

PROBE INPUTS

- Ot Thermostat probe calibration:** (-12.0+12.0°C/ -21+21°F) allows to adjust possible offset of the thermostat probe.
- OE Evaporator probe calibration:** (-12.0+12.0°C/ -21+21°F) allows to adjust possible offsets of the evaporator probe.
- O3 Humidity probe calibration:** (-10+10 RH) allows to adjust possible offsets of the humidity probe.
- P2P Evaporator probe presence:** n= not present: the defrost stops only by time; y= present: the defrost stops by temperature and time.
- P3P Humidity probe presence:** n= not present; y= present.
- LCI Readout with 4 mA :** (-999 ÷ 999). Adjustment of read out corresponding to 4mA signal.
- UCI Readout with 20 mA :** (-999 ÷ 999). Adjustment of read out corresponding to 20mA signal.

DIGITAL INPUTS

- i1P Digital input polarity:** CL : the digital input is activated by closing the contact; OP : the digital input is activated by opening the contact
- i1F Digital input operating mode:** configure the digital input function: **EAL** = generic alarm; **bAL** = serious alarm mode; **PAL** = Pressure switch; **Ht** = heating relay safety; **dor** = door switch
- odc Outputs status when open door:** on = normal; Fan = Fan OFF; oFF = all the loads off
- rrd Outputs restarting after doA alarm:** no = outputs not affected by the doA alarm; yES = outputs restart with the doA alarm;
- did Time interval/delay for digital input alarm:**(0+255 min.) Time interval to calculate the number of the pressure switch activation when I1F=PAL. If I1F=EAL or bAL (external alarms), "did" parameter defines the time delay between the detection and the successive signalling of alarms.

OTHER

- oA1 Light relay configuration (XH260L terminals 3-4, XH260V terminals. 11-12):** ALr = alarm; dEH = dehumidifier; onF = on/off relay: close with instrument on, open with instrument off; Lig = light, Est, dEF not select
- Adr RS485 serial address (0+247)** identifies the instrument within a control or supervising system.
- Ptb Parameter table:** (read only) it shows the original code of the dixell parameter map.
- rEL Software release:** (read only) Software version of the microprocessor.
- Prd Probes display:** (read only) display the temperature values of the evaporator probe Pb2.
- Pr2 Access to the protected parameter list** (read only).

8. DIGITAL INPUT

One digital input is present configurable by user by means of the i1F parameter according to the following descriptions.

8.1 DOOR SWITCH (I1F = dor)

It signals the door status and the corresponding relay output status through the "odc" parameter: **no** = normal (any change); **Fan** = Fan OFF; **oFF** = all the loads are switched off.

Since the door is opened, after the delay time set through parameter "doA", the alarm output is enabled and the display shows the message "dA".

The status of loads depends on the "rrd" parameter:

- with **rrd=no** outputs are not affected by the doA alarm;
- with **rrd=yES** = outputs restart with the doA alarm;

The alarm stops as soon as the external digital input is disabled again. During this time and then for the delay "dot" and "doH" after closing the door, the temperature and humidity alarms are disabled.

8.2 GENERIC ALARM (I1F = EAL)

As soon as the digital input is activated the unit will wait for "did" time delay before signalling the "EAL" alarm message. The outputs status don't change. The alarm stops just after the digital input is de-activated.

8.3 SERIOUS ALARM MODE (I1F = BAL)

When the digital input is activated, the unit will wait for "did" delay before signalling the "bAL" alarm message. The relay outputs are switched OFF. The alarm will stop as soon as the digital input is de-activated.

8.4 PRESSURE SWITCH (I1F = PAL)

If during the interval time set by "did" parameter, the pressure switch has reached the number of activation of the "nPS" parameter, the "PAL" pressure alarm message will be displayed. The compressor and the regulation are stopped. When the digital input is ON the compressor is always OFF.

If the nPS activation in the did time is reached, switch off and on the instrument to restart normal regulation.

8.5 HEATING RELAY SAFETY (i1F=Ht)

With i1F=Ht as soon as the digital input is activated for "did" time heating relay is disabled. The alarm will stop as soon as the digital input is de-activated.

8.6 DIGITAL INPUTS POLARITY

The digital input polarity depends on the "i1P" parameters.
CL : the digital input is activated by closing the contact.
OP : the digital input is activated by opening the contact

9. INSTALLATION AND MOUNTING

Instruments **XW240L** shall be mounted on vertical panel, in a 150x31 mm hole, and fixed using two screws Ø 3 x 2mm. To obtain an IP65 protection grade use the front panel rubber gasket (mod. RG-L). Instrument **XH260V** shall be mounted on vertical panel, in a 72x56 mm hole, and fixed using screws Ø 3 x 2mm. To obtain an IP65 protection grade use the front panel rubber gasket (mod. RG-V). The temperature range allowed for correct operation is 0 - 60 °C. Avoid places subject to strong vibrations, corrosive gases, excessive dirt or humidity. The same recommendations apply to probes. Let the air circulate by the cooling holes.

9.1 XH260V: CUT OUT

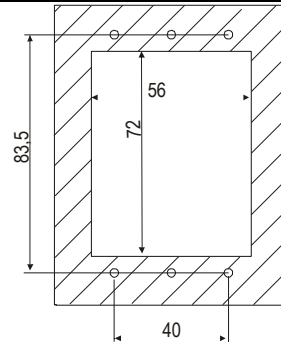

9.2 XH260L: CUT OUT

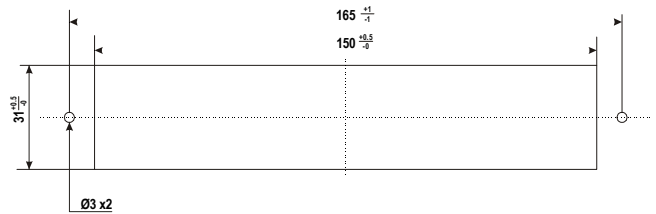

9.3 XH260L INOX FINITURE: MOUNTING

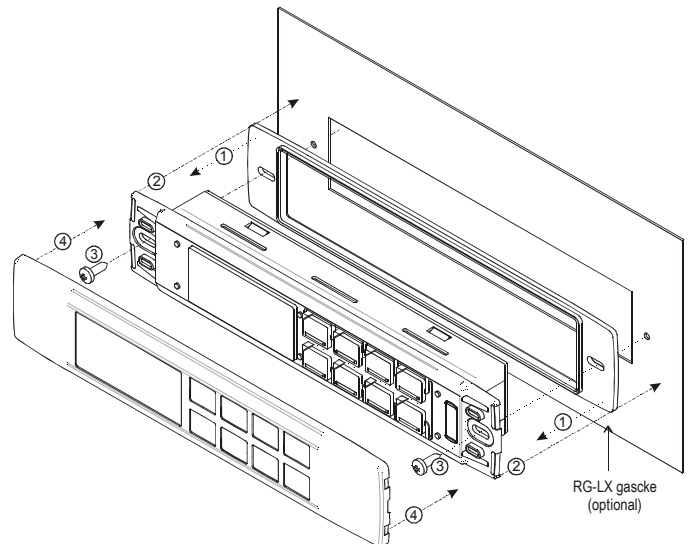

10. ELECTRICAL CONNECTIONS

The instruments are provided with screw terminal block to connect cables with a cross section up to 2,5 mm² for the digital and analogue inputs. Relays and power supply have a Faston connection (6,3mm). Heat-resistant cables have to be used. Before connecting cables make sure the power supply complies with the instrument's requirements. Separate the probe cables from the power supply cables, from the outputs and the power connections. Do not exceed the maximum current allowed on each relay, in case of heavier loads use a suitable external relay.
N.B. Maximum current allowed for all the loads is 20A.

10.1 PROBE CONNECTIONS

The probes shall be mounted with the bulb upwards to prevent damages due to casual liquid infiltration. It is recommended to place the thermostat probe away from air streams to correctly measure the average room temperature.

11. HOW TO USE THE HOT KEY

11.1 HOW TO PROGRAM A HOT KEY FROM THE INSTRUMENT (UPLOAD)

1. Program one controller with the front keypad.
2. When the controller is ON, insert the "Hot key" and push ▲ key; the "uPL" message appears followed a by flashing "End"
3. Push "SET" key and the End will stop flashing.
4. Turn OFF the instrument remove the "Hot Key", then turn it ON again.

NOTE: the "Err" message is displayed for failed programming. In this case push again ▲ key if you want to restart the upload again or remove the "Hot key" to abort the operation.

11.2 HOW TO PROGRAM AN INSTRUMENT USING A HOT KEY (DOWNLOAD)

1. Turn OFF the instrument.
2. Insert a programmed "Hot Key" into the 5 PIN receptacle and then turn the Controller ON.
3. Automatically the parameter list of the "Hot Key" is downloaded into the Controller memory, the "doL" message is blinking followed a by flashing "End".
4. After 10 seconds the instrument will restart working with the new parameters.
5. Remove the "Hot Key".

NOTE the message "Err" is displayed for failed programming. In this case turn the unit off and then on if you want to restart the download again or remove the "Hot key" to abort the operation.

12. ALARM SIGNALING

Message	Cause	Outputs
"P1"	Thermostat probe failure	Compressor and heating outputs off
"P2"	Evaporator probe failure	Defrost and by time
"P3"	Humidity probe failure	Humidity regulation off
"HA"	High temperature alarm	Outputs unchanged
"LA"	Low temperature alarm	Outputs unchanged
"HHA"	High humidity alarm	Outputs unchanged
"HLA"	Low humidity alarm	Outputs unchanged
"dA"	Door switch alarm	Outputs depending on the odC parameter
"EAL"	External alarm	Other outputs unchanged
"BAL"	Serious external alarm	Outputs OFF
"PAL"	Pressure switch alarm	Outputs OFF

The alarm message is displayed until the alarm condition recovers. All the alarm messages are showed alternating with the room temperature except for the "P1" which is flashing. To reset the "EE" alarm and restart the normal functioning press any key, the "rSt" message is displayed for about 3s.

12.1 SILENCING BUZZER

Once the alarm signal is detected the buzzer, if present, can be silenced by pressing any key.

12.2 ALARM RECOVERY

Probe alarms : "P1" (probe1 faulty), "P2", "P3"; they automatically stop 10s after the probe restarts normal operation. Check connections before replacing the probe.
Temperature alarms "HA" and "LA" automatically stop as soon as the thermostat temperature returns to normal values or when the defrost starts.
Humidity alarms "HHA" and "LHA" automatically stop as soon as the humidity returns to normal values.
Door switch alarm "dA" stop as soon as the door is closed.
External alarms "EAL", "BAL" stop as soon as the external digital input is disabled
Pressure switch alarm "PAL" alarm is recovered by switching OFF the instrument.

13. TECHNICAL DATA

Housing: self extinguishing ABS.
Case: XH260L: facia 38x185 mm; depth 76mm; XH260V: facia 100x64 mm; depth 76mm
Mounting: XH260L: panel mounting in a 150x31 mm panel cut-out with two screws. ∅ 3 x 2mm. Distance between the holes 165mm
 XH260V: panel mounting in a 56x72 mm panel cut-out with two screws. ∅ 3x2mm. Distance between the holes 40mm
Protection: IP20.
Frontal protection: IP65 with optional frontal gasket mod. RG-L (XH260L); RGW-V (XH260V).
Connections: Screw terminal block ≤ 2,5 mm² heat-resistant wiring and 6,3mm Faston
Power supply: 230Vac or 110Vac ± 10%; **Power absorption:** 7VA max.
Display: double display + icons; **Inputs:** 1 NTC probe + 4+20mA probe
Digital input: 1 free voltage
Relay outputs: compressor: XH260L: relay SPST 20(8) A, 250Vac;
 XH260V: relay SPST 8(3) A, 250Vac
heater: relay SPST 8(3) A, 250Vac; **defrost:** relay SPST 8(3) A, 250Vac
fans: relay SPST 8(3) A, 250Vac; **humidifier:** relay SPST 8(3) A, 250Vac
de-humidifier: relay SPST 8(3) A, 250Vac
Other output : alarm buzzer (optional); **Data storing:** on the non-volatile memory (EEPROM).
Kind of action: 1B.; **Pollution grade:** normal; **Software class:** A.
Operating temperature: 0÷60 °C.; **Storage temperature:** -25÷60 °C.
Relative humidity: 20÷85% (no condensing)
Measuring and regulation range: NTC probe: -40÷110°C (-58÷230°F)
Resolution: 0,1 °C or 1°C or 1 °F (selectable); **Accuracy (ambient temp. 25°C):** ±0,5 °C ±1 digit

14. WIRING CONNECTIONS

14.1 XH260L

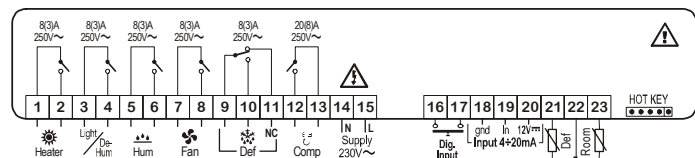

Supply 115Vac: 14-15 terminals

14.2 XH260V

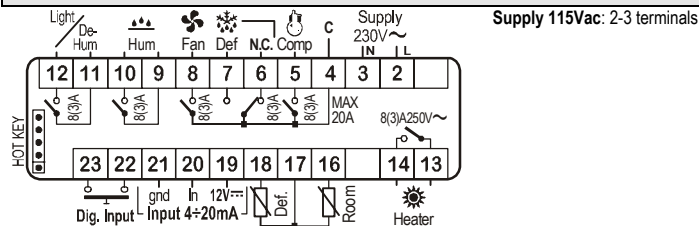

Supply 115Vac: 2-3 terminals

15. DEFAULT SETTING VALUES

Label	Value	Menu	Description	Range
Set T	5.0	---	Temperature Set Point	LS + uS (nu = temperature regulation disabled)
Set H	50.0	---	Humidity Set Point	LSH + uSH (nu = humidity regulation disabled)
dbt	2.0	Pr1	Half dead band width for temperature	0.1°C o 1°F + 25°C o 77°F
dbH	5.0	Pr1	Half dead band width for humidity	0.5 + 50
LS	-40	Pr2	Minimum temperature set point limit	-50.0°C o -58°F + Set T
uS	110	Pr2	Maximum temperature set point limit	Set T + 110°C o 230°F
odS	1	Pr2	Outputs activation delay at start up	0 + 250 min
Ac	1	Pr1	Anti-short cycle delay	0 + 30 min
tHu	db	Pr2	Humidity regulation	db = dehumidifier relay.; cHu = dehum+ compr.; c-H= without dehum. relay
LSH	0.0	Pr2	Minimum humidity set point limit	Lci + Set H
uSH	100.0	Pr2	Maximum humidity set point limit	Set H + uci
cF	°C	Pr2	Measurement unit	°C + °F
rES	dE	Pr2	Resolution (for °C):	in = integer / dE = decimal
rEH	Hd	Pr2	Resolution for RH%:	in = integer / Hd = half digit
tdf	rE	Pr2	Defrost type	rE, rT, in
EdF	in	Pr2	Defrost mode	In, Sd
SdF	0	Pr2	Set point for SMART DEFROST	-30 + +30°C / -22+ +86°F
dtE	8	Pr2	Defrost termination temperature	-50,-0+110°C/ -58+230°F
idF	8	Pr1	Interval between defrosts	1 + 120 h
MdF	20	Pr1	Duration of defrost	0 + 250 min
dFd	it	Pr2	Display during defrost	rt / it / SET / dEF / dEG
dAd	30	Pr2	Defrost display time out	0 + 250 min
Fdt	0	Pr2	Draining time	0+60 min.
dPo	no	Pr2	First defrost after start up	n + y
Hud	no	Pr2	Humidity control during defrost	no; yES
Fnc	c-n	Pr2	Fan operating mode	c-n / c-Y / o-n / o-Y
ALc	Ab	Pr2	Temperature alarm configuration	rE = relative / Ab = absolute
ALL	-40.0	Pr1	Low temperature alarm setting	0°C + 50.0°C / -50.0°C + ALu
ALu	110	Pr1	High temperature alarm setting	0°C + 50.0°C / ALL + 110°C
ALH	1.0	Pr2	Temperature alarm recovery differential	0.1°C o 1°F + 25°C o 77°F
ALd	15	Pr2	Temperature alarm delay	0 + 250 min
dAo	1.3	Pr2	Delay of temperature alarm at start-up	0.0 + 23.5 h
EdA	20	Pr2	Alarm delay at the end of defrost	0 + 250 min
dot	20	Pr2	Delay of temper. alarm after closing the door	0 + 250 min
AHc	Ab	Pr2	Humidity alarm configuration	rE = relative / Ab = absolute
AHL	0.0	Pr1	Low humidity alarm setting	0 + 50 / Lci + AHu
AHu	100	Pr1	High humidity alarm setting	0 + 50 / AHL + uci
AHH	2.0	Pr2	Humidity alarm recovery differential	0.5 + 25
AHd	15	Pr2	Humidity alarm delay	0 + 250 min
dHo	1.3	Pr2	Delay of humidity alarm at start-up	0.0 + 23.5 h
doH	20	Pr2	Alarm delay at the end of defrost	0 + 250 min
nPS	0	Pr2	Pressure switch number	0+15
doA	20	Pr2	Open door alarm delay	0 + 250 min (250 = nu)
ot	0.0	Pr1	Thermostat probe calibration	-12.0 + 12.0
oE	0.0	Pr2	Evaporator probe calibration	-12.0 + 12.0
o3	0.0	Pr1	Humidity probe calibration	-10 + 10
P2P	no	Pr2	Evaporator probe presence	no = absent / YES = present
P3P	YES	Pr2	Humidity probe presence	no = absent / YES = present
Lci	0	Pr2	Readout with 4 mA	-999 + 999
uci	100	Pr2	Readout with 20 mA	-999 + 999
i1P	oP	Pr2	Digital input polarity	cL = open / oP = close
i1F	dor	Pr2	Digital input configuration	dor / PAL / EAL / bAL / Ht
odc	oFF	Pr2	Outputs status when open door	on / Fan / oFF
rrd	YES	Pr2	Outputs restarting after doA alarm	no = no / YES = yes
did	0	Pr2	Digital input alarm delay	0+255 min.
oA1	Lig	Pr2	Light relay configuration (XH260L terminals 3-4, XH260V terminals. 11-12):	ALr = alarm; dEH = dehumidifier; oEF = on/off; Lig = light, EST, dEF not select
Adr	1	Pr2	Serial address	0+247 num
Ptb	1	Pr2	Parameter table	---
rEL	0.1	Pr2	Software release	---
Prd	--	Pr2	Probes display	Pb1+Pb3
Pr2	321	Pr1	Access to the protected parameter list	---

Dixell S.p.a. Via dell'Industria, 27 - 32010 Z.I Pieve d'Alpago (BL) ITALY
 tel. +39 - 0437 - 98 33 - fax +39 - 0437 - 98 93 13
 E-mail:dixell@dixell.com - http://www.dixell.com